

Elektrické blokové schéma

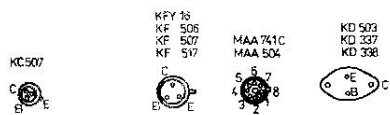

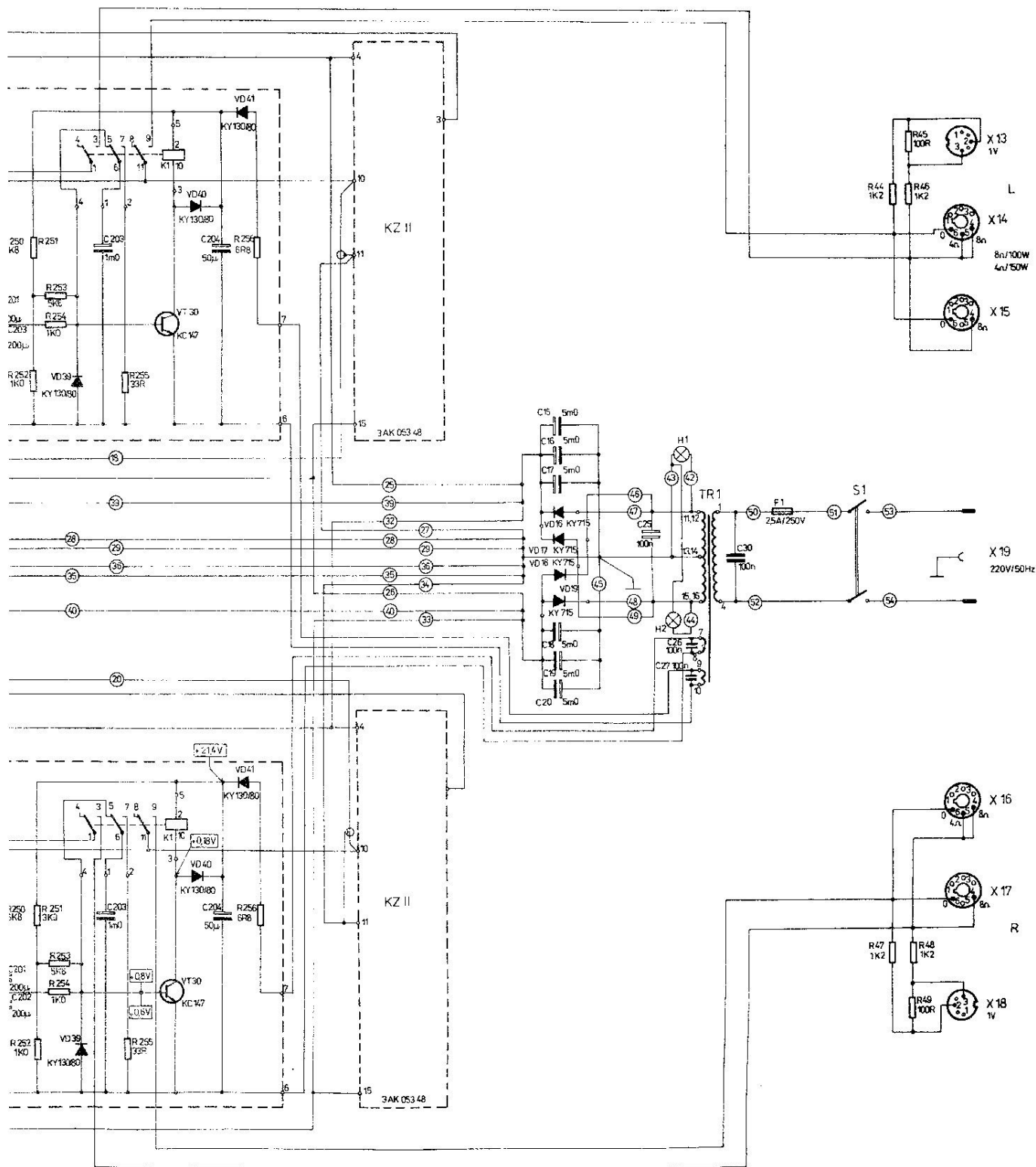

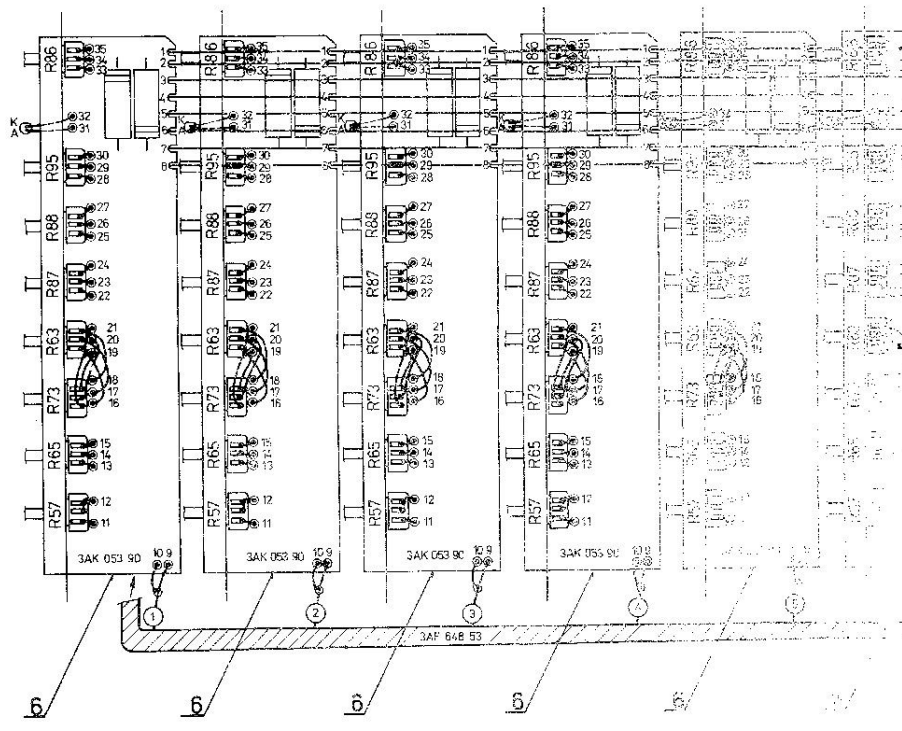

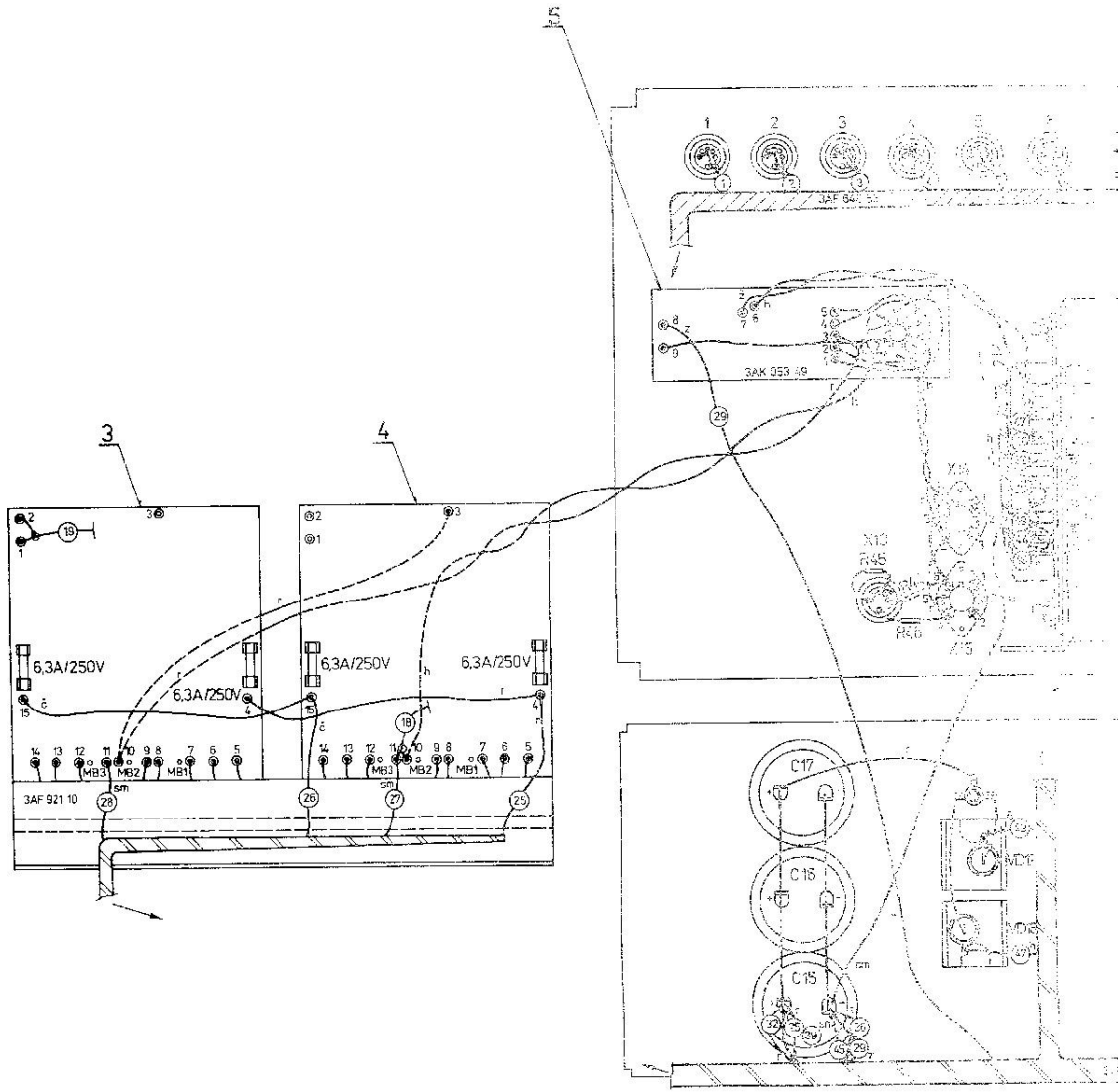
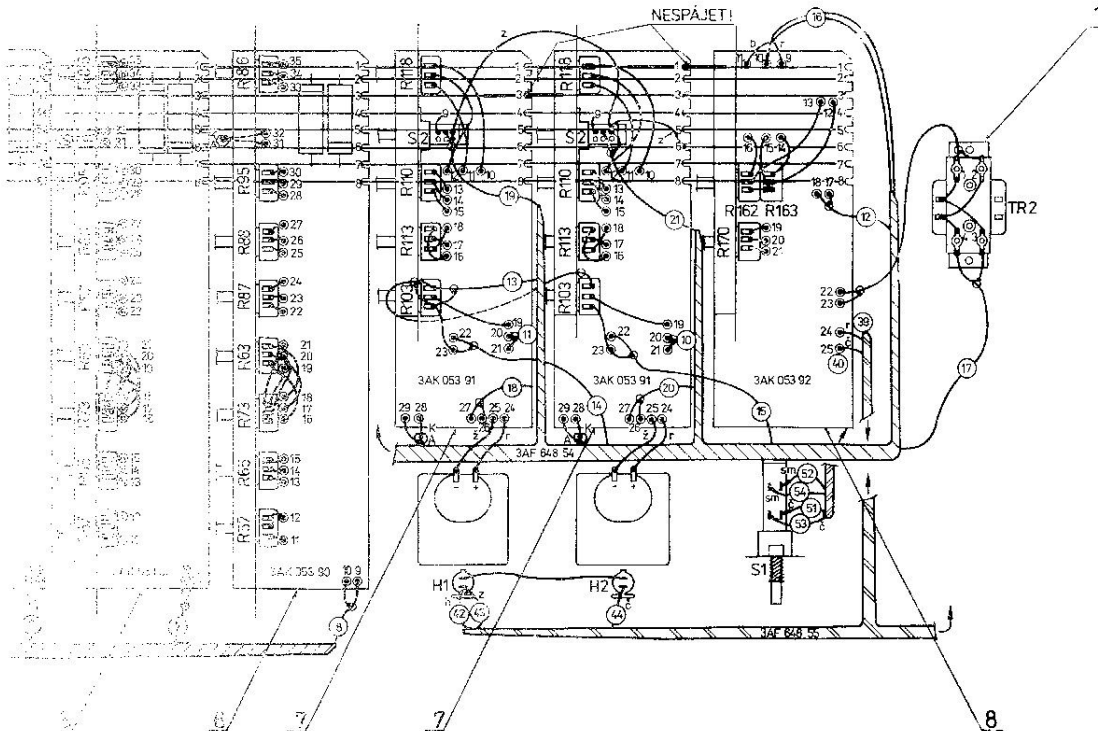
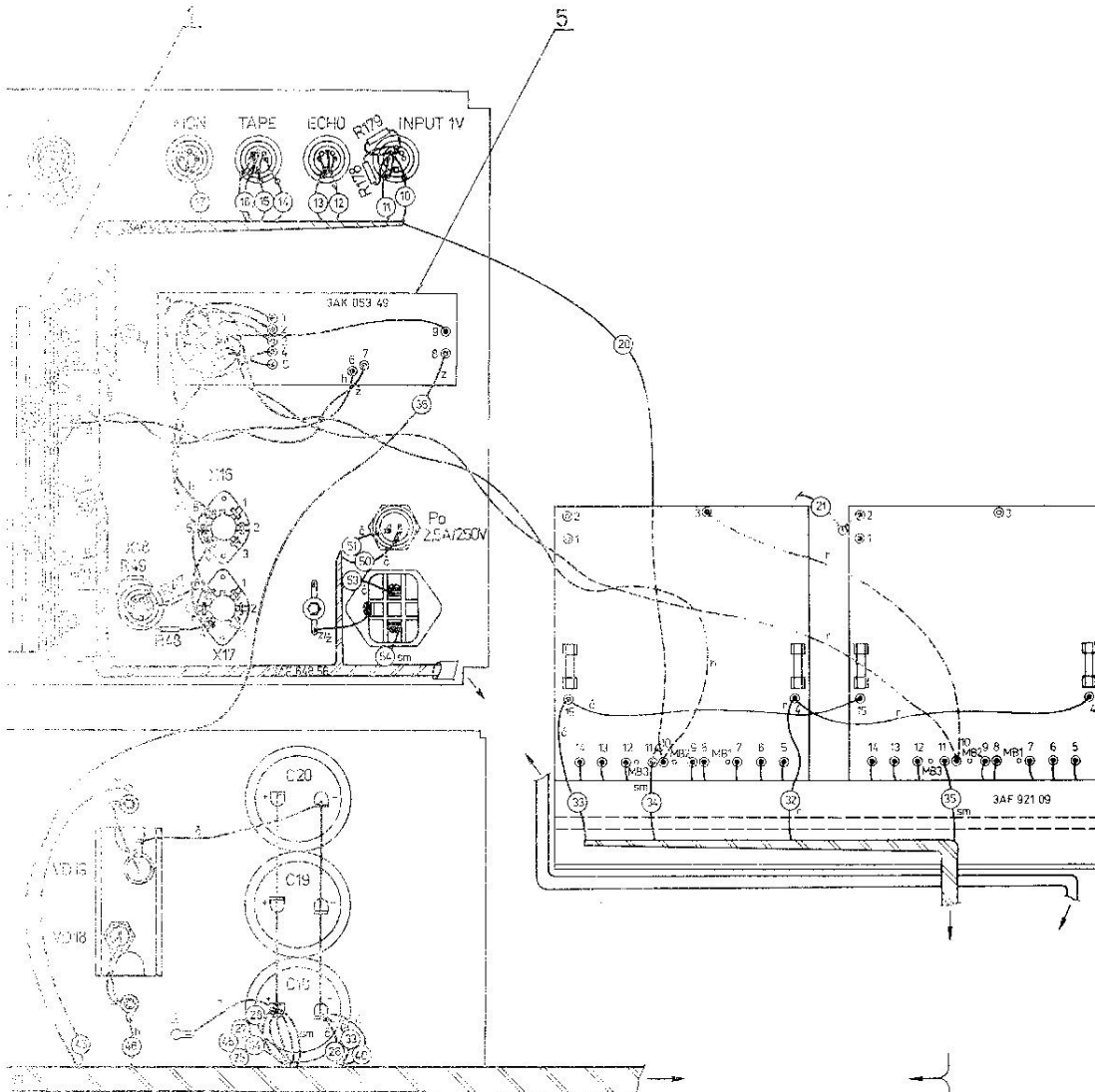





Schéma dosky napájení - PŘÍLOHA V.





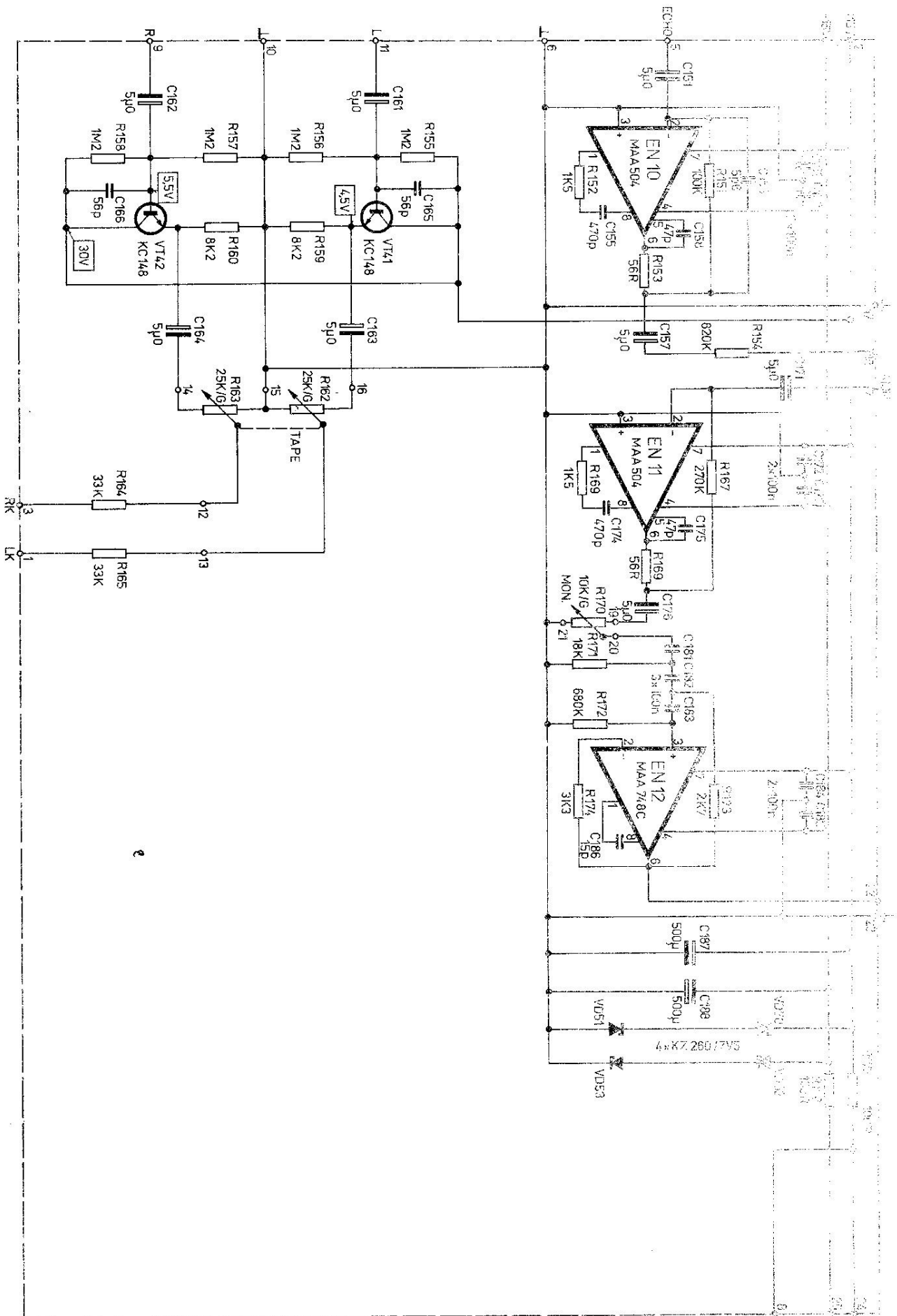
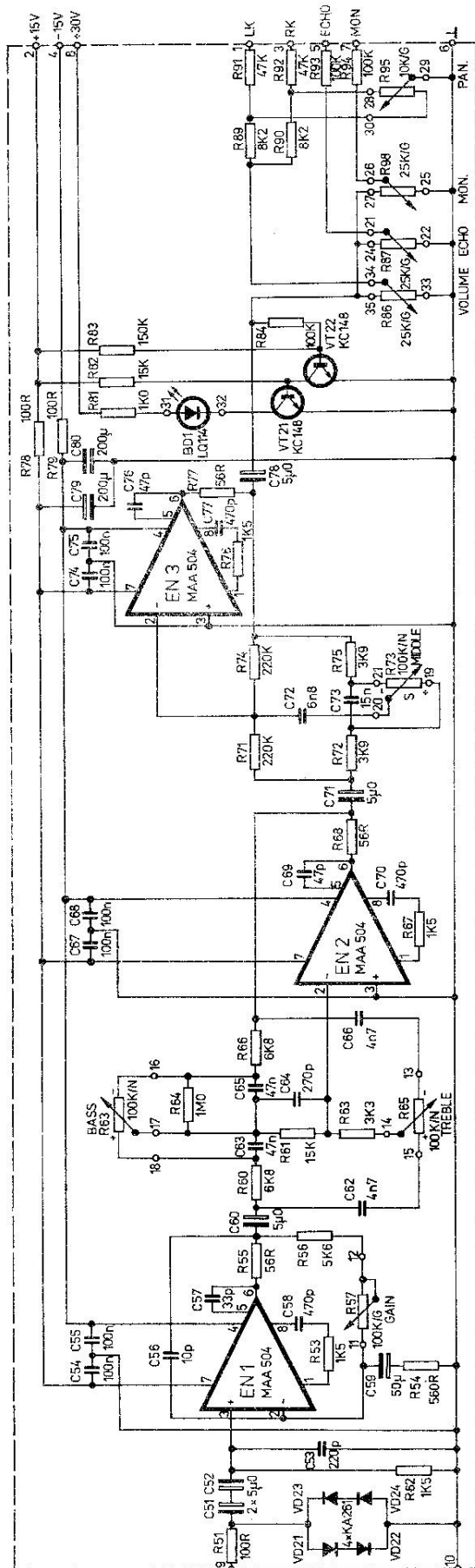

Schéma vstupního zesilovače - PŘÍLOHA IX.